

The Electric Work Method. I. Basic Criteria and General Properties

Hermann Gerhard Hertz* and Signe Kjelstrup Ratkje†

Division of Physical Chemistry, Norwegian Institute of Technology, The University of Trondheim, N-7034 Trondheim-NTH, Norway

Hertz, H. G. and Ratkje, S. K., 1990. The Electric Work Method. I. Basic Criteria and General Properties. – Acta Chem. Scand. 44: 542–553.

We show in this paper that there is a lack of consistency between conventional electrochemistry, stemming from the theory of point charges, and the macroscopic demands of energy conversion in electrochemistry. Conventional electrochemistry gives a static explanation for the EMF of an electrochemical system. A new electrochemistry which focusses on the process connected with the dynamics of the system avoids the inconsistencies which have been pointed out.

The new method, the electric work method, relates the EMF of an electrochemical cell to experimentally accessible, or operationally defined, quantities. The EMF is derived by inspecting coherent changes in a system of conductors and insulators. Any electrochemical system basically has the topological structure of a torus. Material changes along the torus are necessary to obtain an EMF. The charge is not required in order to arrive at expressions for EMFs in a system of conductors. Electrical energy is manifested only if part of the torus consists of an insulator.

1. Introduction

The purpose of the present article and the article to follow¹ is to present and apply¹ an alternative method of studying electrochemical systems, the so-called electric work method.

The method was first developed for isothermal systems by Hertz.² It was later extended to systems with temperature gradients by Hertz and Ratkje.^{3,4} Arguments for the name “electric work method” were given.⁴ The method has been applied to thermocells by Ratkje *et al.*⁵ These studies show how a new treatment of electrochemical systems can be obtained from the first and second laws of thermodynamics, certain laws of delocalized mass and energy conservation, and some phenomenological equations for heat and mass transfer.

In classical electrochemistry ions have an electric charge as a static attribute. Likewise they have local electric potentials, leading to so-called diffusion potentials. Some inherent difficulties in the conventional approach stemming from the concept of electric charge as a static attribute have already been pointed out.² Here the conceptual analysis is made more rigorous. Experiments to prove the conventional approach are suggested. If these fail, some tentative theorems are valid.

The electric work method is consistent with these theorems, but cannot itself disprove the conventional theory. The objective of the present paper is to develop a way of dealing with electrochemical systems, using a new concept

for the electric charge and eliminating the need for local electric potentials.

2. Operational criteria for the existence of electric charges

In order to demonstrate the fundamental problem of conventional electrochemistry, it is necessary to have an indicative operation to prove the existence of electrically charged bodies.

To achieve this aim, we use a set of bodies of macroscopic dimensions which are distributed in space. The bodies are at rest [Fig. 1(a)]. We assume that gravitational force can be neglected. The equilibrium situation is then

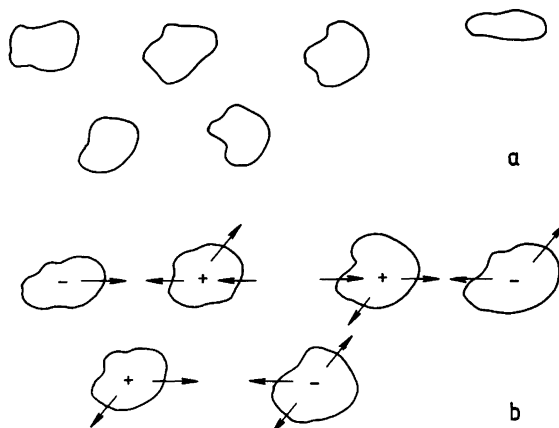

Fig. 1. The entities of the model system: (a) set of bodies of finite size at rest; (b) after supply of energy E_{el} , charged bodies move in directions given by the resultant force of the arrows.

* Permanent address: Institute of Physical Chemistry and Electrochemistry, University of Karlsruhe, Kaiserstrasse 12, 7500 Karlsruhe, FRG.

† To whom correspondence should be addressed.

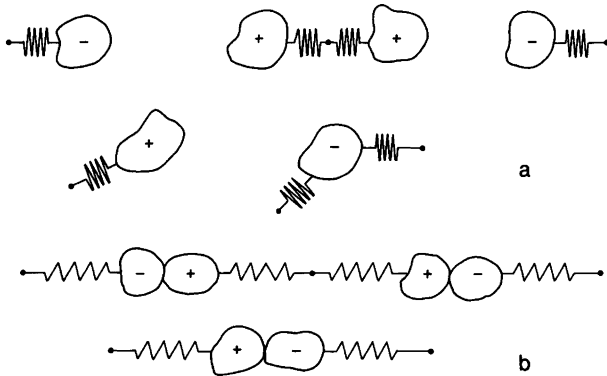

Fig. 2. Conversion of electrical into mechanical energy in a charged body – spring system: (a) the state of maximum electrical energy; (b) the state of maximum mechanical energy.

perturbed by giving the bodies electrical charges. The bodies begin to move, as a consequence of the electric charging (Fig. 1(b)). We will discuss the nature of the electric charging in section 10.

To create a good analogue with electrochemical systems, we replace the kinetic energy of the bodies by potential energy via sets of springs. In order to quantify the electrical work, W_{el} , that can be done by the bodies, as a consequence of their electrical charge, each of the bodies is considered to be attached to springs, (Fig. 2). The springs are fixed in space via adaptors in order to produce proper energy dependence on the distance between bodies. A second purpose of the adaptors is to make possible a reversible conversion of electrical to mechanical energy. The mechanical energy, E_{mech} , and work, W_{mech} , of the system is then represented by the expansion or compression of springs instead of by expressions containing the speeds in Fig. 1(b). The rates of changes of the respective quantities are given by eqn. (1) with F_i as the i th force of the i th spring on a body and dr_i/dt as the rate of body displacement. F_i and dr_i/dt are known from observation of the springs. Neglect of kinetic and magnetic effects implies that all dr_i/dt are small. Eqn. (1) yields the definition of the electric work, W_{el} . The electric work is further related to the electric energy E_{el} , and the mechanical work.

$$\begin{aligned} dE_{mech}/dt &= dW_{mech}/dt = \sum_i F_i (dr_i/dt) \\ &= -dW_{el}/dt = -dE_{el}/dt \end{aligned} \quad (1)$$

At a given instantaneous configuration, the system has electrical and mechanical energy. Immediately after charging we have the situation given by Fig. 2(a), $E_{mech} = 0$. Let the initial state develop into a state of maximum mechanical energy stored by the springs as given in Fig. 2(b). When the charged bodies are in contact as in Fig. 2(b), the charge separation will disappear with time. The springs will go back to the original position, and the mechanical and the remaining electrical energy take the form of thermal en-

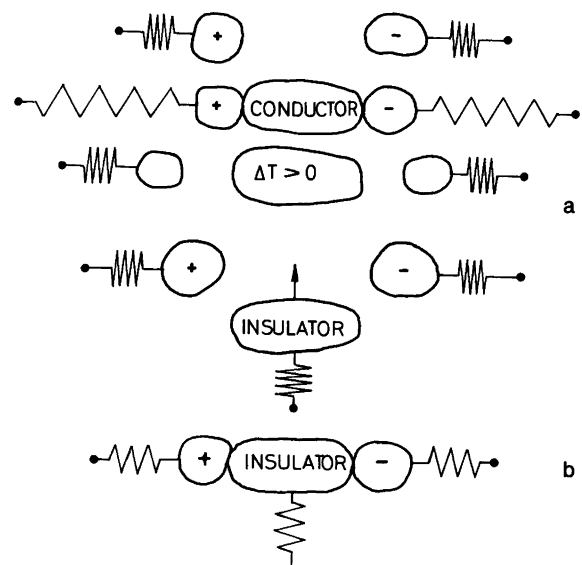

Fig. 3. Conversions of electrical or mechanical energy into thermal energy: (a) total conversion to heat through a conductor; (b) partial conversion to heat through an insulator.

ergy. The final result is that no electrical energy remains, $E_{el} \approx 0$.

A direct conversion from electric to thermal energy may occur. We then place a neutral body, which is a conductor, between two bodies with charges of opposite sign [Fig. 3(a)]. The result is an increase in the temperature of the conductor due to Joule heating.

Electrical energy can be maintained and only partly converted to thermal energy by placing a neutral body, which is an insulator, between or close to the two charged bodies [Fig. 3(b)]. The material of the insulator prevents a total conversion of electrical energy in this case. For the insulator we have eqn. (2), where U is the energy of the

$$dW_{mech}/dt = -dU/dt + dQ/dt - dW_{el}/dt \quad (2)$$

neutral insulator, and dQ/dt is the heat flow into it. We consider eqn. (2) as the indicator equation for detection of electric energy, i.e. the existence of charge. The existence of charge implies that the system is able to perform mechanical work. If for a macroscopic body $dW_{mech}/dt \neq 0$, then at least one of the surrounding bodies carries an electric charge.

3. Coherence in energy conversions

When the charged bodies change position, the corresponding energy conversion occurs in a way governed by the geometry and the material. The processes of body motion, internal energy production and local change of electric energy, at any position, are *coherent*.

This coherence of phenomena will be used to obtain the new general formulation. This phenomenon is central in

electrochemistry. However, it has not received emphasis in conventional electrochemistry.

We introduce the coherence parameter as the “rate parameter of coherent changes”. The coherence parameter coordinates the conversion of mechanical, electrical and thermal energy inside a system of charged and neutral bodies strictly, i.e. rigidly. (See also section 7.) The coherence parameter is a vector in the cases we study. In the case of a conductor, Fig. 3(a), the coherence parameter is the electric current density, j .

In the case of an insulator or a dielectric material [Fig. 3(b)], the coherence parameter is the time change of the displacement D , dD/dt , or the displacement current density. At the border between conductor and insulator we have eqn. (3).

$$-\text{Div} (dD/dt) = j = -(\partial/\partial t)\text{Div} D \quad (3)$$

$\text{Div} D$ means surface divergence. This is essentially the first of Maxwell’s equations after differentiating both sides with respect to time. The situation is illustrated in Fig. 4. The displacement current is manifested inside the body as well as outside it. For instantaneous values of D we have $\text{div} D = 0$. The coherence parameter dD/dt determines the rate of change of the electric energy through eqn. (4), with the

$$\begin{aligned} dE_{el}/dt &= \int_V E(dD/dt)dV \\ &= (d/dt) \left((1/2) \int_V (D^2/\epsilon) dV \right) \end{aligned} \quad (4)$$

time-dependent electric field strength $E = D/\epsilon$, and the dielectric constant, ϵ . D , which is also time-dependent, is connected with the electric charge q by eqn. (5).

$$q = \int_S D u_N dS \quad (5)$$

u_N is the unit vector to the surface S of the body. For the moving conducting body the electric current density is a source of local momentum production at the heterogeneous surface. The mass of a body is m_i , and v_i its velocity. Thus for any of the bodies shown in Fig. 4 we write eqn. (6).

$$\begin{aligned} m_i (dv_i/dt) &= \int_S \tau_N (u_N j) u_N dS \\ &+ \int_S \tau_T [j - (u_N j) u_N] dS + F \end{aligned} \quad (6)$$

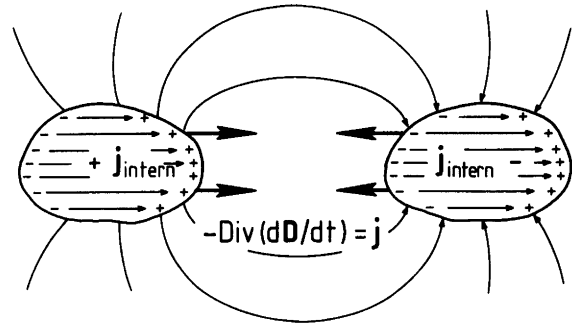

Fig. 4. Electric field lines between charged bodies (schematic). Time dependence of field lines yield the displacement current dD/dt .

The velocity refers to a coordinate system at rest relative to the centre of mass of the system of bodies. According to eqn. (6) the movement of the body is a result of the material discontinuity at the surface when $j \neq 0$. This discontinuity leads to a production of linear momentum, $m_i(dv_i/dt)$, or movement of the body. The parameter τ_N , defined by eqn. (6), is the normal component momentum transference factor, while τ_T is the tangential component momentum transference factor. At the surface of the body j satisfies eqn. (3). The condition $dv_i/dt \approx 0$ was a prerequisite for eqn. (1) and must also be valid for eqn. (6). F is the external force caused by the spring which ensures this condition to be fulfilled.

For small dv_i/dt and j , the rate of change of mechanical energy is opposite and equal to the rate of change of electrical energy. From eqns. (1) and (4) we have eqn. (7).

$$\begin{aligned} dW_{mech}/dt &= \\ \sum_i v_i &\left(\int_S \tau_N (u_N j) u_N dS + \int_S \tau_T [j - (u_N j) u_N] dS \right) \end{aligned} \quad (7)$$

Eqn. (7) describes the role of the current density j as the coherence parameter for correlating motion and energy conversion in conducting materials. In general, when the conducting bodies are moving, there is also a non-vanishing current density j_{intern} , inside the bodies (Fig. 4). This current density causes a production of internal energy even in the homogeneous parts of the material. The local rate of production, rj_{intern}^2 , where r is the specific resistance, must be added to eqn. (7). Thus also coupled to the coherence parameter j there is an internal (irreversible) energy production in homogeneous matter.

The indicator equation for detection of electric charges of a neutral insulator takes the form of eqn. (8).

$$dW_{\text{mech}}/dt =$$

$$v \left(\int \tau_N [u_N(dD/dt)] u_N + \tau_T [dD/dt - [u_N(dD/dt)] u_N] \right) dS \quad (8)$$

To summarize: regions of material discontinuity which are crossed by the coherence parameter are sinks or sources of linear momentum or mechanical energy. The production of linear momentum or mechanical energy at the material discontinuity is reversible through its dependence on j . The displacement current extends to all space between the conducting bodies.

The production of linear momentum is completely analogous to the production of mass or thermal energy at regions of material discontinuity.¹⁻⁴

4. Electrostatic system description

The theory of electrostatics describes in many cases the interaction of charges as the interaction between a large charged body and a small test charge, q . The situation is illustrated in Fig. 5. A chemical example of the test charge would be the proton.

The movement of these two charged bodies relative to each other does produce a displacement current outside and an electrical current inside the bodies, as indicated in Fig. 4. It is an aim of the classical treatment to remove these effects. The fact that $\lim(F'/q)$, for $q \rightarrow 0$, remains finite and non-zero when the positive test charge moves towards the negatively charged body is used to achieve this aim. F' is here the force experienced by the test charge and $\lim(F'/q) = E$, for $q \rightarrow 0$, is the electric field strength. The production of a displacement current outside and an electric current inside the test charge can be ignored in this

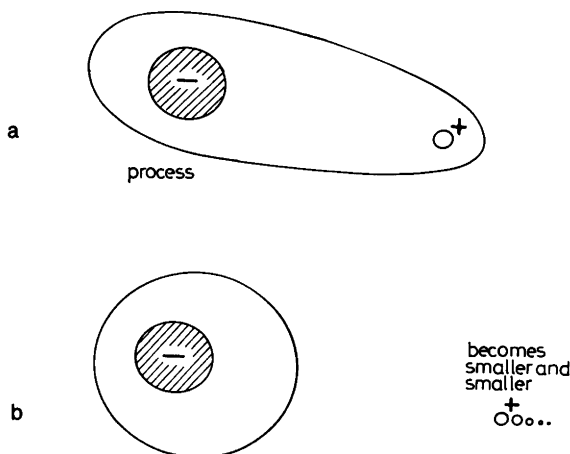

Fig. 5. (a) The interaction between a positive point charge and a large negatively charged body with mass m . The line surrounding the two bodies encloses the system with which we are dealing. (b) The charge is taken to be a property of the large body alone. The positive point charge above does not belong to the system.

limit. However, the internal energy flow in the large body can also be ignored. In other words, there is no mechanism inside the bodies transforming electrical energy to mechanical energy in this picture. This means that the electrical energy of the large body is no longer taken as an energy of a pair of bodies. Furthermore, we have eqn. (9), which

$$E = - \text{grad } \psi(r) \quad (9)$$

gives the electric potential $\psi(r)$ of the large body as a time-independent property. It is not changed by the approach of the test charge. Since the nature of the test charge is irrelevant for the use of $\psi(r)$, it seems that the primary process as such has been forgotten.

Thus in the classical theory in a general situation both interacting charged bodies have intrinsic time-independent properties, which are the charges, and intrinsic time-independent electrical potentials, $\psi(r)$. Movement is caused by the static field strength of one body and the charge of the other body.

$$d(mv)/dt = qE \quad (10)$$

The points of space surrounding the charged body are non-equivalent. This causes the motion. Or, the cause of the motion is intrinsic to the space around the body. In contrast to this eqns. (6)–(8) state that the motion of the bodies is connected with a rate parameter spread over space, i.e. delocalized. Advancement per unit time becomes effective wherever the material changes. Nothing is said about the locus of the cause; this may be anywhere.

5. Application of indicator equation to detect electric charges

Homogeneous, bulk phase systems. Consider a homogeneous solution of cations and anions. The ions, which are microscopic in nature, have an electric potential and an electrical energy according to the theory of electrostatics. Conversions to other energies should be possible. It is the convention of this microscopic picture that other energies are mechanical. For moving ions mechanical energy means kinetic energy. The mechanical energy is increased, while the electrical energy is decreased as a cation and anion approach each other. A complete conversion does not take place, however, and the electrical energy is internal.

This leads to the following inherent problem. As explained above, the criterion for the existence of electric charge on any object, thus on cations and anions, is the production of macroscopic mechanical energy. However, the homogeneous ionic solution has no detectable electrical energy in the sense of our definition. The left-hand side of

eqn. (2) is zero, and so is the right-hand side. This we know from experience.

Assume next that we have two macroscopic bodies, one filled with neutral molecules and one filled with charged particles. There may be surface charges on the body containing cations and anions even if the total body is neutral. The first-mentioned body is now made increasingly smaller, finally becoming a molecule. Then close to the surface of the other body a polarization of the molecule arises. It will obtain mechanical energy and finally be adsorbed. This energy must be restored when moving the molecule from the surface, which means conversion from mechanical energy into electrical energy. A macroscopic body, however, does not move in a similar situation. How can we draw a border between macroscopic and microscopic bodies in order to obtain a criterion as to whether there is electric charge on a body or not? A positive answer implies the existence of a purely mechanical device, as in Fig. 3(b), connected to the probe body and able to take up mechanical energy. The probe body may be as small as we like, provided it can be connected. If such a device exists and moves close to the system, the existence of electric charge is proven. No one has so far carried out a positive experiment using such a device to produce mechanical energy of a homogeneous solution. Our conclusion at the present is therefore theorem I:

It is not possible to convert electrical energy which is exclusively internal electric energy to macroscopic mechanical energy through a homogeneous body of any shape.

Typical of the homogeneous solution is further that there is no coherence of processes during partial energy conversions. This means that the statements about coherence made in section 3 are not valid in the microscopic world. From these statements the crucial question is as follows.

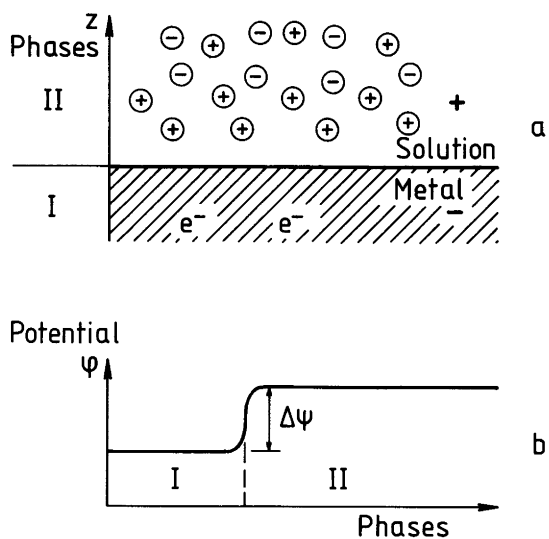

Fig. 6. Proposed charge separation across a metal solution interface: (a) the solution-metal interface, drawn schematically; (b) the variation in electric potential.

Does the movement of the microscopic particles produce long-range coherent changes during the interaction? The answer is no for a simple homogeneous solution. Again we see that these microscopic particles do not model macroscopic observations.

Heterogeneous and anisotropic systems. Do the difficulties described for analysis of a homogeneous body pertain for heterogeneous systems? In order to examine this question, consider as an example two condensed phases, an aqueous salt solution and a metal in contact with each other. According to conventional theory, an electrostatic double layer is created at the interface because cations are driven from the metal into the solution. Positive ions are accumulated in the aqueous phase. The corresponding electrons are left in the metal. The double layer, which is illustrated in Figs. 6(a) and (b), leads to an electric potential difference $\Delta\psi$ across the boundary.

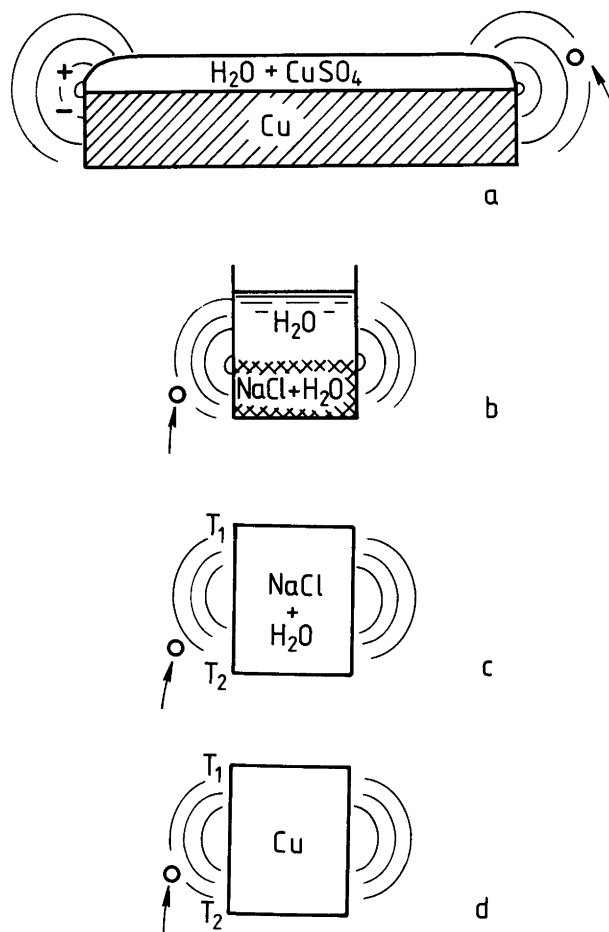

Fig. 7. Experimental systems to prove the local electrostatic field due to charge separation: (a) the salt solution droplet on the metal surface; (b) liquid junction potential in a solution with salt concentration gradient; (c) charge separation from thermal diffusion; (d) thermoelectric potential in a metal. In each case the question to be answered is: does a small neutral body, indicated here by an arrow, move in the inhomogeneous electric field created?

The definition of an electrically charged body is such that the body must be able to produce mechanical energy according to eqn. (2). Thus our question is, can this electrical energy, supposed to yield an amount of work $Fz\Delta\psi$ when one mole of ions is transferred, be verified experimentally by its conversion into macroscopic mechanical energy? In other words, are the statements of section 2 verifiable?

If there is an electric field between the two phases, one possibility of observing it might be the following. A droplet of CuSO_4 solution is placed on a Cu metal piece. Possible field lines should continue in space close to the droplet [Fig. 7(a)].

Only a neutral probe body can be used to check for conversion of internal electric energy to macroscopic mechanical energy; otherwise an electrical state of the body in question is produced by the probe body. A small neutral body being polarized to obtain a dipole moment should move in the field described in Fig. 7(a). Such movement might be observable.

The same type of field lines should also be created in the following three cases:

(1) A concentration gradient of salt exists in a vessel with insulating thin walls [Fig. 7(b)]. According to conventional theory different ion mobilities produce a separation of charges.⁶ This separation should cause an electric field, as the gradient of the electric potential is also outside the material system.

(2) A uniform solution of salt is kept in a temperature gradient. This gives rise to thermal diffusion and charge separation because ion mobilities differ in size.⁷ An electric field should be created inside as well as outside the vessel walls [Fig. 7(c)].

(3) A piece of metal is placed in a temperature gradient. This causes a thermoelectric potential inside the metal,⁷ but also along the surface between the metal ends [Fig. 7(d)].

The question to be answered in all three cases is: Does a small neutral body move along the vessel or the metal in the electric field created? A positive answer would document the field lines and verify operationally the existence of electrical charge separation within the material system. No one has, as far as we know, carried out these experiments. The conversion of internal electric energy connected with electrically charged particles such as ions, to macroscopic mechanical energy is therefore not documented.

Furthermore, the diffusion profiles for cations and anions, relative to each other, should change coherently as the body moves, and the reverse process should also be feasible. This has also never been observed. As a tentative conclusion of this section we therefore propose theorem II:

It is impossible to construct any topologically simple anisotropic or inhomogeneous system such that, owing to atomic interactions and thermal agitation, internal electrical energy is converted into macroscopic mechanical energy.

6. Production of electrical work requires special topological structures

A topologically simple system is topologically equivalent to a sphere;⁸ i.e. it can be constructed by the deformation of a sphere. The sphere may be built of different materials (phases), still it is topologically simple. A characteristic is that any Jordan curve on the sphere can be contracted to a point.⁸ Theorem II is valid for this structure: It cannot produce electrical work.

A torus is topologically non-equivalent to a sphere. The torus is characterized by two types of Jordan curves, which cannot be contracted to a point.⁸ Electrical work can be produced by a heterogeneous body which is topologically classified as a torus.

Conversions involving mechanical and thermal energy. Before we discuss the electrical work connected with a torus, we give an example which is useful for a deeper understanding of electrical phenomena. Consider first a body A, equivalent to a sphere. Let A undergo an adiabatic process such that we have^{9,10} eqn. (11), where U is the internal

$$dU/dt = dW_{\text{mech}}/dt \quad (11)$$

energy of the body and W_{mech} is any kind of mechanical frictional work. The system is illustrated in Fig. 8(a). U is a function of T alone. We then have eqn. (12).

$$dU/dt = (dU/dT)(dT/dt) \quad (12)$$

It follows that dU/dt describes the system expansion, because dT/dt from eqn. (12) gives eqn. (13).

$$\begin{aligned} dV/dt &= (dV/dT)(dT/dt) \\ &= (dV/dT)(dW_{\text{mech}}/dt)/(dU/dT) \end{aligned} \quad (13)$$

We have no direct access to the quantity V through the device illustrated in Fig. 8(a). V is determined by the amount of frictional work supplied. We now add an envelope to the system such that we place the system A inside the envelope B. This gives a pot [Fig. 8(b)]. The energy of the internal body A is given by eqn. (14), where the pres-

$$dU/dt = -p(dV/dt) + T(dS/dt) \quad (14)$$

sure p will be called the work parameter of the pot. The reversible heat flux $dQ/dt = T(dS/dt)$ depends on geometry

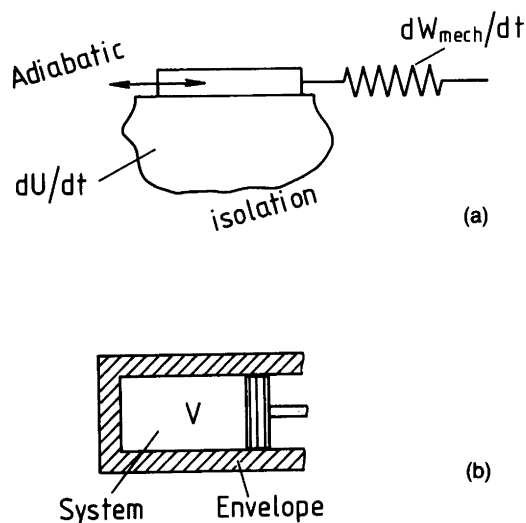

Fig. 8. Conversion between mechanical and thermal energy: (a) in an adiabatically isolated system; (b) in an adiabatic system closed by an envelope.

and material of the envelope. The envelope makes it possible to change V , or record changes in V , independently.

Conversions involving chemical, mechanical, electrical and thermal energy. We turn to the torus built from the materials shown in Fig. 9(b). The compounds A and B react chemically with one another, $A + B = AB$. The energy equation has the form of eqn. (15), where n_{AB} is the mole

$$dU/dt = T(dS/dt) - p(dV/dt) - E^*(dn_{AB}/dt) \quad (15)$$

number of the product AB. E^* is the work parameter of this system. It plays the same role as p in the preceding example. Direct reversible access, or control, of the mole numbers can be obtained through the particular torus construction of the system. It is not possible to obtain such an access either in the homogeneous phase or in any "sphere" system that is inhomogeneous with respect to the sub-

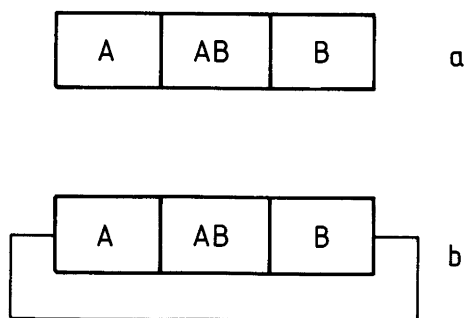

Fig. 9. Conversion between chemical and electrical energy: (a) without electrical contact between A and B; (b) with A and B connected by a conductor.

stances undergoing chemical reaction. The introduction of an envelope to the sphere does not help the situation as in the previous case. The pertinent equations for the sphere system always connect dn_{AB}/dt with dV/dt . For us to have direct access to the mole numbers, the system must be heterogeneous, and, furthermore, a special topological structure like the one illustrated in Fig. 9(b) is needed, the torus. We shall see how necessary control of variables can be obtained using a torus structure.

Mechanical energy is in general obtained from chemical energy when $\Delta G = \mu_{AB} - \mu_A - \mu_B < 0$. The process is then spontaneous. The condition $\Delta G < 0$ is fulfilled by separation of components [Fig. 9(a)]. The reaction is not yet in control in the system illustrated in this figure. Components A and B may react spontaneously by diffusion of A and B through AB, or not at all. Only if A, B and AB are electric conductors, may we gain control over A and B. This is when we connect A and B with a thin conductor, inert to A and B [Fig. 9(b)]. Now $d\Delta G/dt$ is a finite quantity and a reversible process may be obtained, see below. Experimentally this is realized when $dn_{AB}/dt \neq 0$, with $dn_A/dt = -dn_B/dt$.

The quantity $d\Delta G/dt$, occurring as $dU/dt - T(dS/dt) + p(dV/dt)$ in eqn. (15), is the electric work per unit time. It should be noted that this quantity and the system have not been directly related to electricity, apart from the fact that the term 'conductor' is understood by the ability to conduct electric current. It is related to electric energy conversions [it is the quantity $-dW_{el}/dt$ in eqn. (1)], but we shall postpone that point to section 7. It is instructive not to incorporate specifically electric phenomena yet, in order to make the comparison with the previous example of energy conversion more direct.

As we wrote for the volume work, $-p(dV/dt)$, where p was the work parameter belonging to the closed envelope, so we write eqn. (16), where E^* is given by eqn. (17).

$$dW_{el}/dt = -(d\Delta G/dt) = E^*(dn_{AB}/dt) \quad (16)$$

$$E^* = -(\mu_{AB} - \mu_A - \mu_B) \quad (17)$$

It is the calculation of the work parameter, E^* , which is the objective of the electric work method. The needed construction for control of mole numbers is thus a torus. In the torus a chemical reaction can occur by reconnection of the constituents in the longitudinal direction. This produces or consumes work per unit time to or from the surroundings, $E^*(dn_{AB}/dt)$. The quantity E^* is recognized as the electromotive force (in units of $J \text{ mol}^{-1}$). In order to obtain reversibility we need a balancing system to the system of Fig. 9(b). We choose it to be of a similar kind (Fig. 10). In the balancing system, II, the reaction $C + D = CD$ takes place. By adjusting the reaction in system II properly, we can make $dn_{AB}/dt < 0$ and $dn_{AB}/dt > 0$. Owing to continuity we

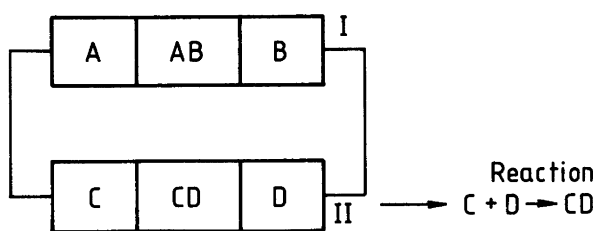

Fig. 10. Reversible production or consumption of AB made possible by a balancing system with the chemical reaction $C + D = CD$.

can have $dn_{AB}/dt = 0$. The composition of CD can be changed to accomplish this. The unique relationship between the two parts of the circuit is given by eqn. (18), with $(dn_{AB}/dt) = z(dn_{CD}/dt)$. Observations give z as a small integer, $z = 1, 2, 3, \dots$

$$\begin{aligned} d\Delta G/dt &= (dn_{AB}/dt)(\mu_{AB} - \mu_A - \mu_B) \\ &= (dn_{CD}/dt)(\mu_{CD} - \mu_C - \mu_D) \end{aligned} \quad (18)$$

Eqn. (17) used in combination with the set-up of Fig. (10) can be regarded as an operational definition of $\Delta\mu$ because in this case the n_i are directly accessible. There is thus no derivation of the Nernst equation. The experimentally accessible route to obtain the mole numbers is through a reversible device such as that constructed in Fig. 10. All EMF values derived in part II¹ are thought to be measured with a device such as Fig. 10.

The purpose of the above presentation has been to show how operational definitions of central quantities for the description of energy conversions can be obtained. The analogy between sub-sections 6 is that both conversions treated make use of a work parameter which is defined through a reversible process. In the arrangement of Fig. 10 primarily we have a transfer of chemical energy from one system to another. (Thermal energy, $T\Delta S$, may also be transferred.) Systems I and II may be separated by a large

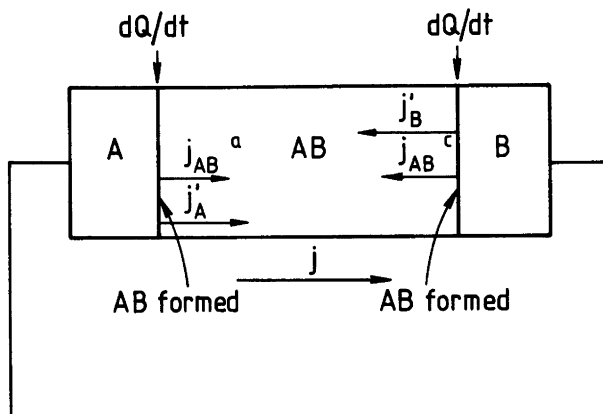

Fig. 11. Mass fluxes and energy fluxes during chemical reaction of A and B to AB.

distance, but they are connected through two wires. The electrical link to the conversion chain is hidden, yet the work parameter E^* is well defined.

The analogy between the cases studied in sub-sections 6 is not complete, since the work parameters p and E^* relate to different topological system structures. For the mechanical-to-thermal energy conversion, the structure of the system is defined by the existence of a closed envelope, while we need a heterogeneous torus in order to convert chemical and other energy to yield electrical work. The statement above is in agreement with theorem II given in section 5.

7. Coherence of phenomena during energy conversions

We shall inspect conditions for the conversion of chemical (and thermal) energy into electrical energy in system I of Fig. 10. We have noted already that observations yield a certain integer z which relates the processes in two different parts of the torus. A closer inspection yields further results: the formation of AB is localized to the interfaces A/AB and AB/B. We have product mass fluxes j_{AB}^a and j_{AB}^c from the anode (superscript a) and cathode (superscript c), respectively, into the product compartment. This is the production of linear momentum at the interfaces, as described in section 3. The product fluxes are formed from excess constituent mass fluxes j'_A and j'_B and the reactant material B and A, respectively. The fluxes are illustrated in Fig. 11. Attention will be devoted to the computation of these fluxes in the next article.¹

The mass flux j_{AB} is related to the concentration gradient of AB. (AB is present as a solute with concentration c_{AB} .) We have Fick's law $j_{AB} = -D(\partial c_{AB}/\partial x)$, where D is the diffusion constant. Furthermore, in the compartment AB, $-\text{div } j_{AB} = \partial c_{AB}/\partial t \neq 0$. In contrast to this, the excess mass fluxes j'_A and j'_B are not connected with a concentration gradient; they also exist in the homogeneous parts of compartment AB. However, in the homogeneous region they have no divergence.

There are also heat fluxes into the system from the surrounding bath at different locations [eqn. (15) and Fig. 11]. Also, energy is transported inside one part and from one part to another: the excess energy flux j'_e .^{3,4}

It turns out that all these fluxes are strictly coupled, i.e. they are proportional to one another, or strictly coherent. We have, for instance, eqn. (19).

$$\begin{aligned} j'_A/j'_B &= C_1 \\ j'_C/j'_D &= C_2 \\ j'_A/j'_C &= C_3 \\ j'_A/j'_D &= C_4 \\ j'_e/j'_A &= C_5 \end{aligned} \quad (19)$$

The indexes C and D refer to constituents of system II. The constants C_1 and C_2 depend on composition in the compartments containing AB and CD, respectively, while C_3, C_4, C_5, \dots depend on the composition in both compartments and in general on their cross-sections. The set of fluxes given by eqn. (19) is not complete, but it serves to illustrate that we can extract from the various factors of proportionality, C_i , one quantity which determines all the fluxes. This gives eqn. (20).

$$\begin{aligned} j'_A &= t_A j^* \\ j'_B &= t_B j^* \\ j'_C &= t_C j^*/z \\ j'_e &= \tau_e j^* \end{aligned} \quad (20)$$

j^* is a vector, the quantities t_i and τ_e depend on composition only, and eqn. (21) holds.

$$\text{div } j^* = 0 \quad (21)$$

Eqn. (21) constitutes the torus character of the arrangements in Figs. 9(b) and 10 as a dynamic property. Note that eqn. (20) are relations which satisfy the observed behaviour given by eqn. (19), and lead to the further equations where

$$C_1 = t_A/t_B, C_2 = t_C/t_D, C_3 = z t_A A_{II}/t_C A_I$$

A_I and A_{II} are cross-sections of systems I and II, respectively. As will be shown later, the mass flux of AB is proportional to j^* ; therefore we have $t_A + t_B = 1$ and likewise $t_C + t_D = 1$.

The properties of j^* described by eqn. (20) explain the term "coherence parameter". Eqn. (20) show that all the fluxes of the system are coherent, and also that j^* is a measure of the strength of the various fluxes. If we replace j^* by $-j^*$ this does not change the result; the coherence parameter has no *a priori* direction. We may, however, give a positive direction to j^* by convention. However, if we have given a direction of j^* by any convention, then the reversal of j^* causes the reversal of all the mass and energy fluxes, apart from one frictional term depending on j^{*2} . The validity of eqn. (20), in particular $j'_e = \tau_e j^*$, defines the conductor.

8. Coherence and work parameters: standard and dimensions

According to eqn. (20) j^* is given by the ratio $j^* = j'_i/t_i$, where i may denote constituents or energy. The quantity j^* can be determined as the ratio between the flux of i and the factor t_i . A standard substance is chosen to define a mea-

suring scale to which all other fluxes can be related. The only condition for choice of standard is that the system is constituted in such a way that rigid coherence of fluxes exists [eqn. (21)].

Let the superscript $^\circ$ indicate a standard substance at standard composition. An example of a standard substance may be AgNO_3 . Then

$$j^{\circ'}_{\text{Ag}} = t^\circ_{\text{Ag}} j^*$$

or with $t^\circ_{\text{Ag}} + t^\circ_{\text{NO}_3} = 1$ and $j^* = j^{\circ'}_{\text{Ag}} + j^{\circ'}_{\text{NO}_3}$ it follows that

$$j^* = j^{\circ'}_{\text{Ag}} / t^\circ_{\text{Ag}} \quad (22)$$

or $j^* = j^\circ$. The excess flux of any constituent A is then given by eqn. (23).

$$j'_A = t_A j^{\circ'}_{\text{Ag}} / t^\circ_{\text{Ag}} = t_A j^\circ \quad (23)$$

The quantities have familiar conventional names. The proportionality factor t_i is the transport number.⁶ We choose the term transference number for t_i in order to emphasize that the phenomena are dealt with on a macroscopic level. The word transport is used when the mechanisms for the process are dealt with.

The symbol $j^* = n^\circ / At$ is the electric current density, given in dimensions $\text{mol m}^{-2} \text{s}^{-1}$. We are free to multiply j^* by q and divide by q , where q is the electric charge in Coulomb [eqn. (24)].

$$j^* = (n^\circ/q)(q/At) \quad (24)$$

n° is the mole number of standard substance, q/n° is Faraday's constant, F , and $j = q/At$ is the electric current density with dimensions A m^{-2} . It may be seen that the charge only enters in a formal way. Using F , our result is given by eqn. (25).

$$j^* = j/F \quad (25)$$

The excess energy flux, j'_e , may also be chosen to define the coherence parameter. This is relevant for processes where the mole as a unit for changing matter does not occur, for instance in a thermocouple. The coherence parameter may then be related to the rate of a process in a standard system which converts, say $A j^*$ moles AgNO_3 per unit time. We then use eqn. (22) and relate the rate of advancement of a

process to the rate of advancement of a standard process. From eqns. (16) and (25) we have eqn. (26).

$$-A^{-1}d\Delta G/dt = E^*j^* = E^*j/F = Ej \quad (26)$$

The identity gives E , the electric work per unit charge in V from E^*/F . The three parts to the right of eqn. (26) characterize what we call the electric work method. We have a product of a work parameter and a coherence parameter to which fluxes (rates of deformation) are coupled. The dimension is work per unit time, and the division by the time element dt indicates that we are dealing with a process occurring in time. In the next article we shall use the current density in $A\ m^{-2}$; here we wanted to show that the topological and material properties of the system are decisive, not the electrical charge.

9. Manifestations of electricity

We have seen above that it has been possible to discuss several phenomena related to electric energy conversion without referring explicitly to electricity. Only neutral components and systems have been dealt with. In this respect we have taken the consequence of the early conclusion by Taylor:¹¹ the EMF of a cell (at constant T) is a function of energies which are only molecular. It is now urgent to discuss the following questions. In what way does electricity enter our system description? What is the meaning of the concept of charge?

In order to answer these questions, let us return to Fig. 9(b) and change it. The modified system is shown in Fig. 12. A capacitor is added between the electrode leads. This gives a different completion of the torus than the one illustrated in Figs. 9(b) and 10. After we have built the system together, the intrinsic EMF immediately exists, and a current will flow. Since the capacitor is added in the circuit, the system comes to rest. We then have eqn. (27).

$$EI = -I(\mu_{AB} - \mu_A - \mu_B)/F = RI^2 + (I/C) \int Idt \quad (27)$$

where R is the resistance of the system and C is the capacitance. In the integral I appears as an instantaneous param-

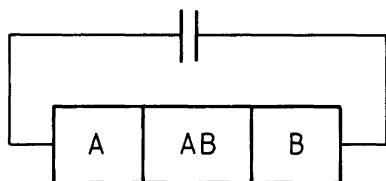

Fig. 12. Conversion between chemical and electrical energy. The electrodes are connected to a capacitor.

eter of coherent changes at the conductor-insulator boundary in the capacitor. The coherence parameter, I , has its continuation into the non-conducting region through the displacement current AdD/dt , [section 3, eqn. (3)].

The integral $\int Idt$ may be called the integral transformed coherence, transformed from I to AdD/dt according to eqn. (3). The conventional term for $\int Idt$ is the charge, q . The charge is conventionally thought to be a substance or a fluidisation. Through the integral definition it becomes a path measure. If we divide I by F according to eqn. (25) it is a path in dimensionless space like the degree of advancement of a chemical reaction. It measures how long was the path for transformation of chemical or other energy into electrical energy. After the transformation has taken place, the electrical energy is determined by the space and material between the capacitor plates and the size of the integral [eqn. (4)].

The significance of C can be seen by dividing eqn. (27) by I and forming the time derivative, eqn. (28).

$$R(dI/dt) + (I/C) = 0 \quad (28)$$

The solution for I of this equation is given by eqn. (29).

$$I = I_0 \exp(-t/RC) \quad (29)$$

When $t \rightarrow \infty$ and $I \rightarrow 0$, this gives eqn. (30) from eqn. (27).

$$EI = (I/C) \int Idt \quad (30)$$

However $I \approx dn_{AB}/dt$, which gives $\int Idt \approx n_{AB}$. In particular, for $I \rightarrow 0$, we have eqn. (31).

$$E = (1/C) \int' Idt \quad (31)$$

Thus if C is very large, the process takes a long time. The integral $\int Idt$ from 0 to t' is large and the amount of AB formed is also large. Much chemical energy has been transformed, and has been transformed to electric energy. The chemical energy which is transformed is given by eqn. (32),

$$\Delta n_{AB}(\mu_{AB} - \mu_A - \mu_B) = -E_{el} - \int RI^2 dt \quad (32)$$

where the electric energy, E_{el} , gained is given by eqn. (4). (Composition dependencies of the μ_i have been neglected.)

In this section we have pointed out that a heterogeneous torus is the type of body which is required for conversion of

chemical energy into electric energy. This is also true for conversions of thermal energy and mechanical energy into electrical energy. In torus systems containing only conductors, the concept of charge is not necessary for a description of energy conversions. However, electric energy may occur owing to the term RI^2 .

In section 2 we made the assumption that the electric current is so small that magnetic energy can be neglected. Moreover, if I is so small that $E \gg IR$, even the electrical energy can be suppressed. For instance, in the arrangement given by Fig. 10 there is an adjustment for which we have eqn. (33) or (34) or similar equations. dW_{chem}^i/dt is the rate

$$EI = dE_{el}/dt = (dW_{chem}^I/dt + dW_{chem}^{II}/dt) \approx 0 \quad (33)$$

$$EI = dE_{el}/dt = (dW_{chem}/dt + dW_{therm}/dt) \approx 0 \quad (34)$$

of change of chemical free energy of system i . dW_{therm}/dt is the rate of any kind of reversible thermal energy change. These equations show that there are non-electric energy conversions, and the production of electrical energy is zero. However, the electric work parameter E is well defined and measurable. This is a basic feature of the electric work method.

The special features of electricity are only manifested if part of the torus consists of an insulator. The charge may be defined as the time integral of the coherence parameter. Space between conducting bodies is necessary to define electric energy (section 2). The amount of electric energy is determined by the insulator construction. The closed-system or rigid-ring property of the coherence parameter is defined through the divergences $\text{div}(dD/dt) = j$ at the insulator-conductor boundaries, and $\text{div}j = 0$ in the conductor and finally $\text{div}(dD/dt) = 0$ in the insulator. This combined system of j and dD/dt constitutes the torus. The coherence parameter is not a movement in itself, but regulates "rigidly" all material and property fluxes and movements.

Finally, let us return to Fig. 9(a), in order to be exact about the phenomena described: we said that apparently nothing was happening when the different parts were built together. The exact statement is that, provided the capacitance of the system is negligible, nothing will happen. There is a conversion of chemical energy into electrical energy, proportional to the amount of AB formed, but the amount is extremely small when the capacitance of the system is small.

10. Production of mechanical work from electrical energy

So far we have shown that by the aid of a torus which is materially heterogeneous and partly open, but which is closed with respect to the coherence parameter, chemical energy can be converted into electrical energy [eqn. (35)].

$$\int (dW_{chem}/dt)dt = \int (dW_{el}/dt)dt = E_{el} = \frac{1}{2} \int EDdV \quad (35)$$

In section 2 we stated that the detection of electrical energy is given by the convertability into mechanical energy. It remains to be shown how electrical energy can be supplied to material systems such that conversion to mechanical energy becomes feasible. That is, we give the theory of charging which was lacking so far. We start with the system in Fig. 12. Let the distance between the plates be variable (Fig. 13). Then, let us begin to make the distance x larger by application of external work, $dx/dt = v > 0$. Thereby we supply linear momentum. This causes a change of the field in the capacitor, thus we have $dD/dt \neq 0$. From dD/dt , I results, which in turn gives dn_{AB}/dt and j inside the system. The reverse process can also happen, of course. Mechanical energy can thus be produced.

The coherence parameter is directly connected with dD/dt , [eqn. (3)]. At the discontinuity of the capacitor plates the production or consumption of linear momentum or mechanical energy leads to a rate of conversion from electrical to mechanical energy when the plates move with respect to one another [eqn. (36)], where F is the force

$$(d/dt) \frac{1}{2} \int ED dV = v\tau_N A_j = Fv \quad (36)$$

given by the springs in Fig. 13, τ_N is the momentum transference factor of eqn. (6) and A is the cross-section of the capacitor. There is also a rate of change of chemical energy. We have eqn. (37) for an ideal capacitor with a plate distance x .

$$\begin{aligned} \frac{1}{2} (dC/dt)E^2 &= (d/dt)(1/2)(\int EDdV) \\ &= -(1/2)(A/x^2)E^2(dx/dt) \\ &= (1/2)(dq/dt)E \end{aligned} \quad (37)$$

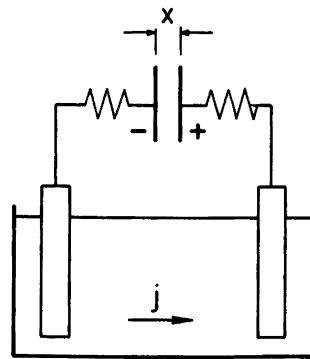

Fig. 13. Mechanical work is converted into electrical work by moving capacitor plates.

With $I = dq/dt = F(dn_{AB}/dt)$, and $v = dx/dt$, we find eqn. (38).

$$\frac{1}{2} EF(dn_{AB}/dt) = F(dx/dt) = -\frac{1}{2} (A/x^2)E^2(dx/dt) \quad (38)$$

This equation connects the mechanical force F , to the electric work parameter, E , the EMF. It is seen from this example that chemical energy can be transformed to macroscopic mechanical energy via electrical energy. A similar example is given when a dielectric is put into the capacitor.

In order to perform conversion from electrical to mechanical energy without a chemical process being directly connected, we have to decouple the capacitor plates from the generating cell, the heterogeneous open torus. This is shown in Figs. 14(a) and (b). Now we have two charged bodies fixed to respective springs, acceptors (donors) of mechanical energy. Each of the plates has an electrical charge which is now a constant of the system. The charge is the integrated coherence parameter; it gives the degree to which the capacitor plates have been operated on in the configuration of the heterogeneous open torus.

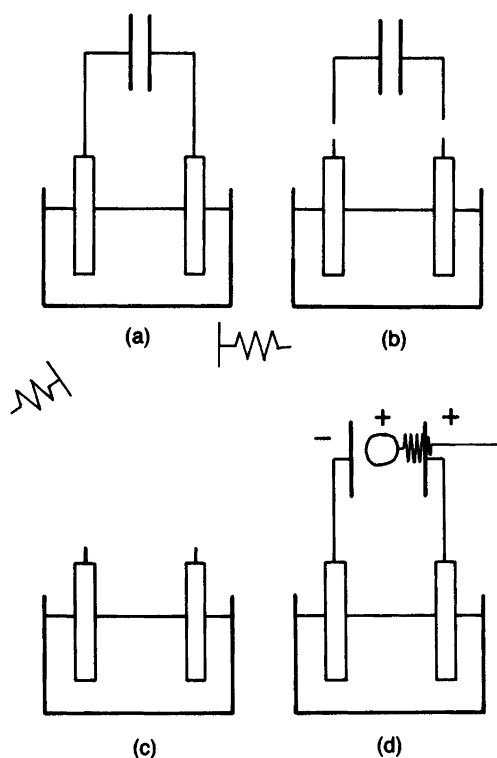

Fig. 14. Chemical energy is manifested by mechanical energy: (a) the open-circuit electrochemical cell; (b) capacitor plates decoupled from electrodes in the cell; (c) capacitor plates moved to any distance from each other by application of springs; (d) a charged body is moved within two capacitor plates.

After the separation operation, the capacitor plates, or the bodies in the general case, may be moved to any position. Energy conversion is accomplished by the aid of the springs as shown in Fig. 14(c). Kinetic energy is avoided (section 2). The energy conversion is described by eqns. (4) and (6).

In Fig. 14(d) a charged body has been brought between the plates of the capacitor. Movement of the body causes dC/dt and dn_{AB}/dt . In section 1 we took for granted the charging of bodies, without describing the process. Now we see that charging means to incorporate a body in a proper heterogeneous torus and then to decouple it from the torus.

Electric energy and charged bodies are derivatives from the heterogeneous torus construction in the electric work method. The torus is prior to the charge. Charge does not exist if it is not made in a process. The significance of the number z appearing after eqn. (18) is an apparent charge, related to the atomic number of an atom with atomic number Z , by $z < Z$.

Acknowledgements. The authors are grateful to The Royal Norwegian Foundation for Sciences and Humanities for support given to H. G. H. for his stay in Norway.

References

1. Hertz, H. G. and Ratkje, S. K. *Acta Chem. Scand.* 44 (1990) 554.
2. Hertz, H. G. *Electrochemistry – a Reformulation of Basic Principles*, Springer, Berlin 1980.
3. Hertz, H. G. and Ratkje, S. K. *J. Electrochem. Soc.* 136 (1989) 1691.
4. Hertz, H. G. and Ratkje, S. K. *J. Electrochem. Soc.* 136 (1989) 1698.
5. Ratkje, S. K., Ikeshoji, T. and Syverud, K. *J. Electrochem. Soc.* Submitted.
6. Bockris, J. O'M. and Drazic, D. M. *Electro-chemical Science*, Taylor and Francis Ltd., London 1972, p. 24.
7. Haase, R. *Thermodynamics of Irreversible Processes*, Addison-Wesley, New York 1969.
8. Müller, K. P. and Wölpert, H. *Anschauliche Topologie*, Teubner, Stuttgart 1976.
9. Guggenheim, E. A. *Thermodynamics*, North-Holland, Amsterdam 1950.
10. Born, M. *Phys. Z.* 22 (1921) 218.
11. Taylor, P. B. *J. Phys. Chem.* 31 (1927) 1478.

Received August 14, 1989.